



# ASTRON CORPORATION



All Metered Units  
Now With Backlit Displays

MODEL SS-25CDM



MODEL RM-35M



MODEL SS-10TK7180



MODEL VS-20ML



MODEL ISO 4812-12



MODEL SRM-30M-2



PREMIER MANUFACTURER OF: DC-DC Converters • DC-AC Inverters  
Power Supplies • Battery Chargers

CONTÁCTENOS: PBX 8058150-317 6448753/ dcomercial@alfayomegacom.co / www.alfayomegacom.co

# ASTRON POWER SUPPLIES

• HEAVY DUTY • HIGH QUALITY • RUGGED • RELIABLE •

## SPECIAL FEATURES

- SOLID STATE ELECTRONICALLY REGULATED
- FOLD-BACK CURRENT LIMITING Protects Power Supply from excessive current & continuous shorted output
- CROWBAR OVER VOLTAGE PROTECTION on all Models except RS-3A, RS-4A, RS-5A, RS-4L, RS-5L
- MAINTAIN REGULATION & LOW RIPPLE at low line input Voltage
- HEAVY DUTY HEAT SINK • CHASSIS MOUNT FUSE

- THREE CONDUCTOR POWER CORD except for RS-3A
- ONE YEAR WARRANTY • MADE IN U.S.A.

## PERFORMANCE SPECIFICATIONS

- INPUT VOLTAGE: 105-125 VAC
- OUTPUT VOLTAGE: 13.8 VDC ± 0.05 volts (Internally Adjustable: 11-15 VDC)
- RIPPLE Less than 5mv peak to peak (full load & low line)



MODEL VS-50M

## SL SERIES



- LOW PROFILE POWER SUPPLY

MODEL	Continuous Duty (Amps)	ICS (Amps)	Size (IN) H x W x D	Shipping Wt. (lbs.)
SL-10	7	10	2 1/2 x 7 1/2 x 9 1/4	11
SL-11A	7	11	2 1/2 x 7 1/2 x 9 1/4	12
SL-11R	7	11	2 1/2 x 7 x 9 1/4	12
SL-11R-MC	7	11	5 1/2 x 7 1/4 x 9 1/4	13
SL-11R-GE	7	11	5 1/2 x 7 x 9 1/4	13
SL-11R-RA	7	11	4 1/4 x 7 x 9 1/4	13
SL-11R-EFJ	7	11	5 1/2 x 7 1/4 x 9 1/4	13
SL-11MG	7	11	5 1/4 x 7 1/2 x 9 1/4	13
SL-11SM/GTX/M1225	7	11	5 1/2 x 7 x 9 1/4	13
SL-15R	12	15	2 1/2 x 7 x 9 1/4	13
SL-15R-GE	12	15	5 1/2 x 7 1/4 x 9 1/4	14
SL-15SM/GTX/M1225	12	15	5 1/2 x 7 x 9 1/4	15
SL-15R-RA	12	15	4 1/4 x 7 1/4 x 9 1/4	14
SL-15R-EFJ	12	15	5 1/2 x 7 1/4 x 9 1/4	14
SL-15CDM	12	15	5 1/2 x 7 1/2 x 9 1/4	14

## RS-L SERIES



- POWER SUPPLIES WITH BUILT IN CIGARETTE LIGHTER RECEPTACLE

MODEL	Continuous Duty (Amps)	ICS* (Amps)	Size (IN) H x W x D	Shipping Wt. (lbs.)
RS-3L	2.5	3	3 X 4 1/4 x 5 1/4	4
RS-4L	3	4	3 1/2 X 6 1/2 x 7 1/4	6
RS-5L	4	5	3 1/2 X 6 1/2 x 7 1/4	7

## RM SERIES



MODEL RM-35M

- 19" RACK MOUNT POWER SUPPLIES

MODEL	Continuous Duty (Amps)	ICS* (Amps)	Size (IN) H x W x D	Shipping Wt. (lbs.)
RM-12A	9	12	5 1/4 x 19 x 8 1/4	16
RM-20A	16	20	5 1/4 x 19 x 8 1/4	16
RM-35A	25	35	5 1/4 x 19 x 12 1/2	38
RM-50A	37	50	5 1/4 x 19 x 12 1/2	50
RM-60A	50	55	7 x 19 x 12 1/2	55

• Separate Volt and Amp Meters

RM-12M	9	12	5 1/4 x 19 x 8 1/4	16
RM-20M	16	20	5 1/4 x 19 x 8 1/4	16
RM-35M	25	35	5 1/4 x 19 x 12 1/2	38
RM-50M	37	50	5 1/4 x 19 x 12 1/2	50
RM-60M	50	55	7 x 19 x 12 1/2	55

## RS-A SERIES



MODEL RS-7A

MODEL	Continuous Duty (Amps)	ICS (Amps)	Size (IN) H x W x D	Shipping Wt. (lbs.)
RS-3A	2.5	3	3 x 4 1/4 x 5 1/4	4
RS-4A	3	4	3 1/2 x 6 1/2 x 7 1/4	5
RS-5A	4	5	3 1/2 x 6 1/2 x 7 1/4	7
RS-7A	5	7	3 1/2 x 6 1/2 x 9	9
RS-10A	7.5	10	4 x 7 1/2 x 10 1/4	11
RS-12A	9	12	4 1/2 x 8 x 9	13
RS-20A	16	20	5 x 9 x 10 1/2	18
RS-35A	25	35	5 x 11 x 11	27
RS-50A	37	50	6 x 13 3/4 x 11	46
RS-70A	57	70	6 x 13 3/4 x 12 1/2	48

## RS-M SERIES



MODEL RS-35M

MODEL	Continuous Duty (Amps)	ICS (Amps)	Size (IN) H x W x D	Shipping Wt. (lbs.)
• Switchable volt and Amp meter RS-12M	9	12	4 1/2 x 8 x 9	13
• Separate volt and Amp meters RS-20M	16	20	5 x 9 x 10 1/2	18
RS-35M	25	35	5 x 11 x 11	27
RS-50M	37	50	6 x 13 3/4 x 11	46
RS-70M	57	70	6 x 13 3/4 x 12 1/2	48

## VS-M AND VRM-M SERIES



MODEL VS-35M

- Separate Volt and Amp Meters • Output Voltage adjustable from 2-15 volts • Current limit adjustable from 1.5 amps to Full Load.

MODEL	Continuous Duty (Amps)			ICS* (Amps)	Size (IN) H x W x D	Shipping Wt. (lbs.)
	@13.8VDC	@10VDC	@5VDC	@13.8V		
VS-12M	9	5	2	12	4 1/2 x 8 x 9	13
VS-20ML	16	9	4	20	5 x 9 x 10 1/2	20
VS-35M	25	15	7	35	5 x 11 x 11	29
VS-50M	37	22	10	50	6 x 13 3/4 x 11	46
VS-70M	57	34	16	70	6 x 13 3/4 x 12 1/2	48

• Variable rack mount power supplies

VRM-35M	25	15	7	35	5 1/4 X 19 X 12 1/2	38
VRM-50M	37	22	10	50	5 1/4 X 19 X 12 1/2	50

\*ICS - Intermittent Communication Service (50% Duty Cycle 5 min. on 5 min. off)

**RS-S SERIES**



**MODEL RS-12S**

- Built in speaker

MODEL	Continuous Duty (Amps)	ICS (Amps)	Size (IN) H x W x D	Shipping Wt. (lbs.)
RS-10S	7.5	10	4 x 7½ x 10¾	12
RS-12S	9	12	4½ x 8 x 9	13
RS-20S	16	20	5 x 9 x 10½	18
SL-11S	7	11	2¾ x 7¾ x 9¾	12



**MODEL RM-35M-BB**

**BATTERY BACKUP POWER SUPPLIES**

The RS-10A, RS-12A, RS-12MBB, RS-20A, RS-20MBB, RM-35A/M, RM-50A/M, RM-10A, RM-12A/M, RM-20A/M & RM-60A/M are available with battery revert and trickle charge circuit with zero switch over time. (Battery not included.) To specify the backup circuit add BB after the model number.

**NEW DC-DC CONVERTERS**

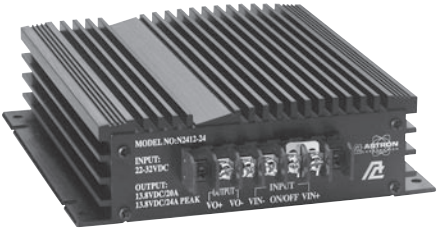

**MODEL N2412-12, N2412-24, A4812-12 & A4812-24**

Standard Features:

- Overvoltage Protection
- Overcurrent Protection
- Short Circuit Protection
- Terminal Block Connectors
- Extra Terminal provided to allow converters to be turned ON and OFF with the ignition switch.

MODEL	N2412-12	A4812-12	N2412-24	A4812-24
Input Voltage	22-32 VDC	30-56 VDC	22-32 VDC	30-56 VDC
Output Voltage	13.8 VDC	13.8 VDC	13.8 VDC	13.8 VDC
Line/Load Regulation	.03 VDC	.03 VDC	.04 VDC	.04 VDC
Ripple	20 mVrms	20 mVrms	20 mVrms	20 mVrms
Continuous Current	10 Amps	9 Amps	20 Amps	18 Amps
Peak Current	12 Amps	12 Amps	24 Amps	24 Amps
Overvoltage Protection	17 VDC	17 VDC	17 VDC	17 VDC
Efficiency	88%	88%	88%	88%
Dimensions	2" x 6.2" x 6"	2" x 6.2" x 6"	2" x 6.2" x 7"	2" x 6.2" x 7"
Weight	1.8 Lbs	1.8 Lbs	2 Lbs	2 Lbs

**ISOLATED DC-DC CONVERTERS**

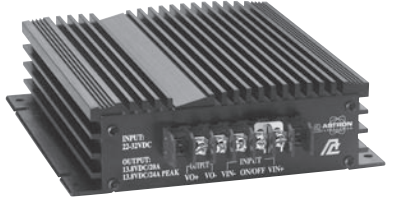

The ISO converters were designed for use on electric forklifts (where high line transients and voltage spikes are common) and will operate on positive or negative electrical systems. They incorporate over voltage protection, over load protection, terminal block connections and an extra terminal to allow the converters to be turned on/off with the ignition switch.

MODEL	ISO2412-12	ISO4812-12	ISO2412-24	ISO4812-24
Input Voltage	22-32 VDC	36-72 VDC	22-32 VDC	36-72 VDC
Output Voltage	13.8 VDC	13.8 VDC	13.8 VDC	13.8 VDC
Continuous Current	10 Amps	10 Amps	20 Amps	20 Amps
Peak Current	12 Amps	12 Amps	24 Amps	24 Amps
Combined load/line regulation	+/- 1%	+/- 1%	+/- 1%	+/- 1%
Output Ripple	20 mVrms	20 mVrms	20 mVrms	20 mVrms



**MODEL 1212**

**MODEL 1212-18**

**MODEL 1212 & 1212-18 Switching Regulated Converter.**

Designed for FM transceivers and other applications requiring 12 volt power source converted from 12 volt positive ground battery. Regulation with pulse width modulation at 20 KHz.

Input - 12 V DC (Positive ground only). Functional from - 11 V DC to - 16 V DC. Output + 13.8 V DC (Negative ground only).

	1212	1212-18
Output Voltage	13.8 V DC (±.2 V DC)	13.8 V DC (±.2 V DC)
Line/Load Regulation	200 mV	200mV
Ripple/Noise	50 mV RMS	50 mV RMS
Current Continuous	6 Amp	14 Amp
Current (ICS)	7 Amp	18 Amp
Current Limit	8 Amp	19 Amp
Case	2¾" (H) x 6" (W) x 6" (D)	2¾" x 6" x 12"
Shipping Weight	2 lbs.	4 lbs.



**MODEL 2412-40 & 4812-40**

**Switching Regulated Converter.**

Designed for FM transceivers and other applications requiring 12 volt power source converted from 24 volt battery. Regulation with pulse width modulation at 20 KHz.

MODEL	2412-40	4812-40
Input (negative ground only)	22-32V DC	30-56V DC
Output Voltage (±.2 V DC)	13.8V DC	13.8V DC
Line/Load Regulation	200 mV	200 mV
Ripple/Noise	50 mV RMS	50 mV RMS
Current Continuous	32 Amp	32 Amp
Current Limit	40 Amp	40 Amp
Case	4½" x 6" x 12"	4½" x 6" x 12"
	(H) (W) (D)	(H) (W) (D)
Shipping Weight	5.5 lbs.	5.5 lbs.

# ...POWER ON WITH ASTRON

## SWITCHING POWER SUPPLIES...

### SPECIAL FEATURES:

- HIGH EFFICIENCY SWITCHING TECHNOLOGY SPECIFICALLY FILTERED FOR USE WITH COMMUNICATIONS EQUIPMENT, FOR ALL FREQUENCIES INCLUDING HF
- HEAVY DUTY DESIGN
- LOW PROFILE, LIGHT WEIGHT PACKAGE
- EMI FILTER
- MEETS FCC CLASS B

### PROTECTION FEATURES:

- CURRENT LIMITING
- OVERVOLTAGE PROTECTION
- FUSE PROTECTION
- OVER TEMPERATURE SHUTDOWN

### SPECIFICATIONS:

INPUT VOLTAGE: 115 VAC 50/60HZ  
OR 220 VAC 50/60HZ  
SWITCH SELECTABLE

OUTPUT VOLTAGE: 13.8VDC

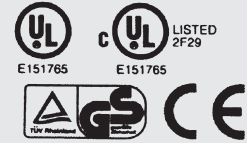

AVAILABLE WITH THE FOLLOWING APPROVALS: UL, CUL, CE, TUV.



MODEL SS-18

### DESKTOP SWITCHING POWER SUPPLIES

MODEL	CONT. (Amps)	ICS	SIZE (inches)	Wt.(lbs.)
SS-10	7	10	2 $\frac{1}{8}$ x 6 x 9	3.2
SS-12	10	12	2 $\frac{1}{8}$ x 6 x 9	3.4
SS-18	15	18	2 $\frac{1}{8}$ x 6 x 9	3.6
SS-25	20	25	2 $\frac{1}{8}$ x 7 x 9 $\frac{1}{8}$	4.2
SS-30	25	30	3 $\frac{1}{4}$ x 7 x 9 $\frac{1}{8}$	5.0



MODEL SS-25M

### DESKTOP SWITCHING POWER SUPPLIES WITH VOLT AND AMP METERS

MODEL	CONT. (Amps)	ICS	SIZE (inches)	Wt.(lbs.)
SS-25M*	20	25	2 $\frac{1}{8}$ x 7 x 9 $\frac{1}{8}$	4.2
SS-30M*	25	30	3 $\frac{1}{4}$ x 7 x 9 $\frac{1}{8}$	5.0



MODEL SRM-30

### RACKMOUNT SWITCHING POWER SUPPLIES

MODEL	CONT. (Amps)	ICS	SIZE (inches)	Wt.(lbs.)
SRM-10	7	10	3 $\frac{1}{2}$ x 19 x 9 $\frac{1}{8}$	4.3
SRM-12	10	12	3 $\frac{1}{2}$ x 19 x 9 $\frac{1}{8}$	4.7
SRM-18	15	18	3 $\frac{1}{2}$ x 19 x 9 $\frac{1}{8}$	5.0
SRM-25	20	25	3 $\frac{1}{2}$ x 19 x 9 $\frac{1}{8}$	6.5
SRM-30	25	30	3 $\frac{1}{2}$ x 19 x 9 $\frac{1}{8}$	7.0

### WITH SEPARATE VOLT & AMP METERS

MODEL	CONT. (Amps)	ICS	SIZE (inches)	Wt.(lbs.)
SRM-25M	20	25	3 $\frac{1}{2}$ x 19 x 9 $\frac{1}{8}$	6.5
SRM-30M	25	30	3 $\frac{1}{2}$ x 19 x 9 $\frac{1}{8}$	7.0



MODEL SRM-30M-2

### 2 ea SWITCHING POWER SUPPLIES ON ONE RACK PANEL

MODEL	CONT. (Amps)	ICS	SIZE (inches)	Wt.(lbs.)
SRM-25-2	20	25	3 $\frac{1}{2}$ x 19 x 9 $\frac{1}{8}$	10.5
SRM-30-2	25	30	3 $\frac{1}{2}$ x 19 x 9 $\frac{1}{8}$	11.0

### WITH SEPARATE VOLT & AMP METERS

MODEL	CONT. (Amps)	ICS	SIZE (inches)	Wt.(lbs.)
SRM-25M-2	20	25	3 $\frac{1}{2}$ x 19 x 9 $\frac{1}{8}$	10.5
SRM-30M-2	25	30	3 $\frac{1}{2}$ x 19 x 9 $\frac{1}{8}$	11.0

\*ICS - Intermittent Communication Service

# CUSTOM POWER SUPPLIES FOR RADIOS

SWITCHING BASE STATION MODELS PICTURED



MODEL SS-10TK



MODEL SS-12IF



MODEL SS-12SM/GTX/M1225



MODEL SS-25CDM



MODEL SS-10EFJ-98



MODEL SS-10RA



MODEL SS-10F1721  
SS-12F1721  
SS-18F1721



MODEL SS-10TK7180  
SS-12TK7180  
SS-18TK7180



MODEL SS-10TK71/8150  
SS-12TK71/8150  
SS-18TK71/8150

EF JOHNSON GT-ML81 EF JOHNSON GT-ML83 EF JOHNSON 9800 SERIES	SS-12EFJ SS-18EFJ SS-10EFJ-98, SS-12EFJ-98, SS-18EFJ-98
GE MARC SERIES GE MONOGRAM SERIES & MAXON SM-4000 SERIES	SS-12MC SS-10MG, SS-12MG
ICOM IC-F1020 & IC-F2020 ICOM IC-F320/IC-F420 ICOM IC-F111S, IC-F121S, IC-F211S & IC-F221S ICOM IC-F1721D	SS-10IF, SS-12IF SS-10IC, SS-12IC, SS-18IC SS-12ICF-S, SS-18ICF-S SS-10F1721, SS-12F1721, SS-18F1721
KENWOOD TK760, 762, 840, 860, 940, 941 KENWOOD TK760H, 762H KENWOOD TK-7150/8150 KENWOOD TK7180, TK8180, TK7160, TK8160	SS-10TK SS-12TK OR SS-18TK SS-10TK71/8150, SS-12TK71/8150, SS-18TK71/8150 SS-10TK7180, SS-12TK7180, SS-18TK7180
MOTOROLA LOW POWER SM50, SM120, GTX/M1225 MOTOROLA HIGH POWER SM50, SM120, GTX/M1225 MOTOROLA RADIUS & GM 300 MOTOROLA RADIUS & GM 300 MOTOROLA RADIUS & GM 300 MOTOROLA CDM 750, CDM1250 and CDM1550 MOTOROLA ASTRO XTL5000	SS-10SM/GTX/M1225 SS-12SM/GTX/M1225, SS-18SM/GTX/M1225 SS-10RA SS-12RA SS-18RA SS-25CDM SS-10XTL, SS-12XTL, SS-18XTL
UNIDEN SMH1525, SMU4525	SS-10SMU, SS-12SMU, SS-18SMU
VERTEX — FTL-1011, FT-1011, FT-2011, FT-7011	SS-10V, SS-12V, SS-18V



# ASTRON POWER SUPPLIES

• HEAVY DUTY • HIGH QUALITY • RUGGED • RELIABLE •

### SPECIAL FEATURES

- SOLID STATE ELECTRONICALLY REGULATED
- FOLD-BACK CURRENT LIMITING Protects Power Supply from excessive current & continuous shorted output
- CROWBAR OVER VOLTAGE PROTECTION on all Models
- MAINTAIN REGULATION & LOW RIPPLE at low line input Voltage
- HEAVY DUTY HEAT SINK • CHASSIS MOUNT FUSE
- THREE CONDUCTOR POWER CORD
- ONE YEAR WARRANTY • MADE IN U.S.A.

### PERFORMANCE SPECIFICATIONS

- INPUT VOLTAGE: 105-125 VAC
- OUTPUT VOLTAGE: 28 VDC  $\pm$  0.05 volts (Internally Adjustable: 22-32 VDC)
- RIPPLE Less than 5mv peak to peak (full load & low line)

## POWER SUPPLIES WITH 28 VDC OUTPUT VOLTAGE

### LS SERIES



MODEL LS-3A

MODEL	Continuous Duty (Amps)	ICS* (Amps)	Size (IN) H x W x D	Shipping Wt. (lbs.)
LS-3A	3	4	3 3/4 X 6 1/2 x 9	9
LS-10A	8	10	5 X 9 x 10 1/2	18
LS-18A	12	18	5 X 11 x 11	27
LS-25A	18	25	6 X 13 3/4 x 11	46
LS-35A	27	35	6 X 13 3/4 x 12 1/4	49
LS-35M (with meters)	27	35	6 X 13 3/4 x 12 1/4	49

### LSRM-A SERIES



MODEL LSRM-25A

### 19" x 5 1/4" RACK MOUNT POWER SUPPLIES

MODEL	Continuous Duty (Amps)	ICS* (Amps)	Size (IN) H x W x D	Shipping Wt. (lbs.)
LSRM-18A	12	18	5 1/4 X 19 x 12 1/2	38
LSRM-25A	18	25	5 1/4 X 19 x 12 1/2	50
LSRM-35A	27	35	7 X 19 x 12 1/2	55

- Separate volt and amp meters

LSRM-18M	12	18	5 1/4 X 19 x 12 1/2	38
LSRM-25M	18	25	5 1/4 X 19 x 12 1/2	50
LSRM-35M	27	35	7 X 19 x 12 1/2	55

### VLS SERIES



MODEL VLS-10M

- Separate Volt and Amp Meters • Output Voltage adjustable from 5-32 volts • Current limit adjustable from 1.5 amps to Full Load

MODEL	Continuous Duty (Amps)			ICS* (Amps)	Size (IN) H x W x D	Shipping Wt. (lbs.)
	@28VDC	@12VDC	@5VDC			
VLS-10M	8	4	2	10	5 x 9 x 10 1/2	20
VLS-25M	18	10	5	25	6 x 13 3/4 x 11	46
VLS-35M	27	15	8	35	6 x 13 3/4 x 12 1/4	49

## 28 VDC SWITCHING POWER SUPPLIES



MODEL SLS-15

### SPECIAL FEATURES:

- HIGH EFFICIENCY SWITCHING TECHNOLOGY SPECIFICALLY FILTERED FOR USE WITH COMMUNICATIONS EQUIPMENT, FOR ALL FREQUENCIES INCLUDING HF
- HEAVY DUTY DESIGN
- LOW PROFILE, LIGHT WEIGHT PACKAGE
- EMI FILTER
- MEETS FCC CLASS B

### PROTECTION FEATURES:

- CURRENT LIMITING
- OVERVOLTAGE PROTECTION
- FUSE PROTECTION
- OVER TEMPERATURE SHUTDOWN

### SPECIFICATIONS:

INPUT VOLTAGE: 115 VAC 50/60HZ  
OR 230 VAC 50/60HZ  
SWITCH SELECTABLE

OUTPUT VOLTAGE: 28VDC



MODEL SLSRM-15

MODEL	CONT. (Amps)	ICS	SIZE	Wt. (lbs.)
<b>DESKTOP MODELS</b>				
SLS-15	12.5	15	3 3/4 X 7 x 9 3/4	5
<b>RACKMOUNT MODELS</b>				
SLSRM-15	12.5	15	3 1/2 X 19 x 9 3/4	6
SLSRM-15-2	2 ea SLS-15 IN ONE RACK PANEL			11

\*ICS - Intermittent Communication Service (50% Duty Cycle 5 min. on 5 min. off)

# ...POWER ON WITH ASTRON DC TO AC POWER INVERTERS...



**Operate the following equipment from any 12vdc source including  
Cars, Trucks, Boats and RV's etc.**

Laptop and notebook computers - Facsimiles - Battery chargers for laptop & notebook computers.  
Cellular phones and camcorders - Computer peripherals, scanners and printers - Stereos, VCR and TV.  
Test equipment, power drills and other electronic equipment.

## SPECIFICATIONS

	Pi-50W	Pi-150W	Pi-250W	Pi-1000W	Pi-1750W	Pi-3000W
Output power						
30 minutes	50 watts	150 watts	250 watts			2600 watts
Surge:	75 watts	400 watts	500 watts	2000 watts	3000 watts	3000 watts (5 mins.)
Continuous:	50 watts	150 watts	200 watts	950 watts	1750 watts	2500 watts
Input voltage:	10 to 15 VDC	10 to 15 VDC	10 to 15 VDC	10 to 15 VDC	10 to 15 VDC	10 to 15 VDC
Output voltage:	115 VAC RMS $\pm$ 5%	115 VAC RMS $\pm$ 5%	115 VAC RMS $\pm$ 5%	115 VAC RMS $\pm$ 5%	115 VAC RMS $\pm$ 5%	115 VAC RMS $\pm$ 5%
Output frequency:	60 Hz $\pm$ 0.01%	60 Hz $\pm$ 0.01%	60 Hz $\pm$ 0.01%	60 Hz $\pm$ 0.01%	60 Hz $\pm$ 0.01%	60 Hz $\pm$ 0.01%
Output waveform:	modified sinewave, phase corrected	modified sinewave, phase corrected	modified sinewave, phase corrected	modified sinewave, phase corrected	modified sinewave, phase corrected	modified sinewave, phase corrected
Efficiency:	Approx 90%	Approx 90%	Approx 90%	Approx 90%	Approx 90%	Approx 90%
No load current draw:	<70mA	<70mA	<150mA	<300mA	<600mA	<600mA
Low battery alarm:		10.7V	10.7V	10.7V	10.7V	10.7V
Low battery shutdown:	10V	10V	10V	10V	10V	10V
Dimensions (HxWxL):	2.5"x35"x1.25"	1.5"x4.5"x4.5"	1.5"x4.5"x6"	3"x9"x10"	3"x9"x16"	6.25"x8"x18.5"
Weight:	6.5 oz	1.13 lbs	1.25 lbs	5.25 lbs	8.25 lbs	20 lbs
Protection features:						
Over temperature:	Electronic Shutdown	Electronic Shutdown	Electronic Shutdown	Electronic Shutdown	Electronic Shutdown	Electronic Shutdown
Overload:	Electronic Shutdown	Electronic Shutdown	Electronic Shutdown	Electronic Shutdown	Electronic Shutdown	Electronic Shutdown
Short circuit:	-----	Electronic Shutdown	Electronic Shutdown	Electronic Shutdown	Electronic Shutdown	Electronic Shutdown
Reverse polarity:	-----	Fuse	Fuse	Fuse	Fuse	Fuse
GFCI Protection:	-----	-----	-----	Pi-1000W	Pi-1750W	-----

# ASTRON SMARTCHARGE BATTERY CHARGERS

## MICROPROCESSOR CONTROLLED

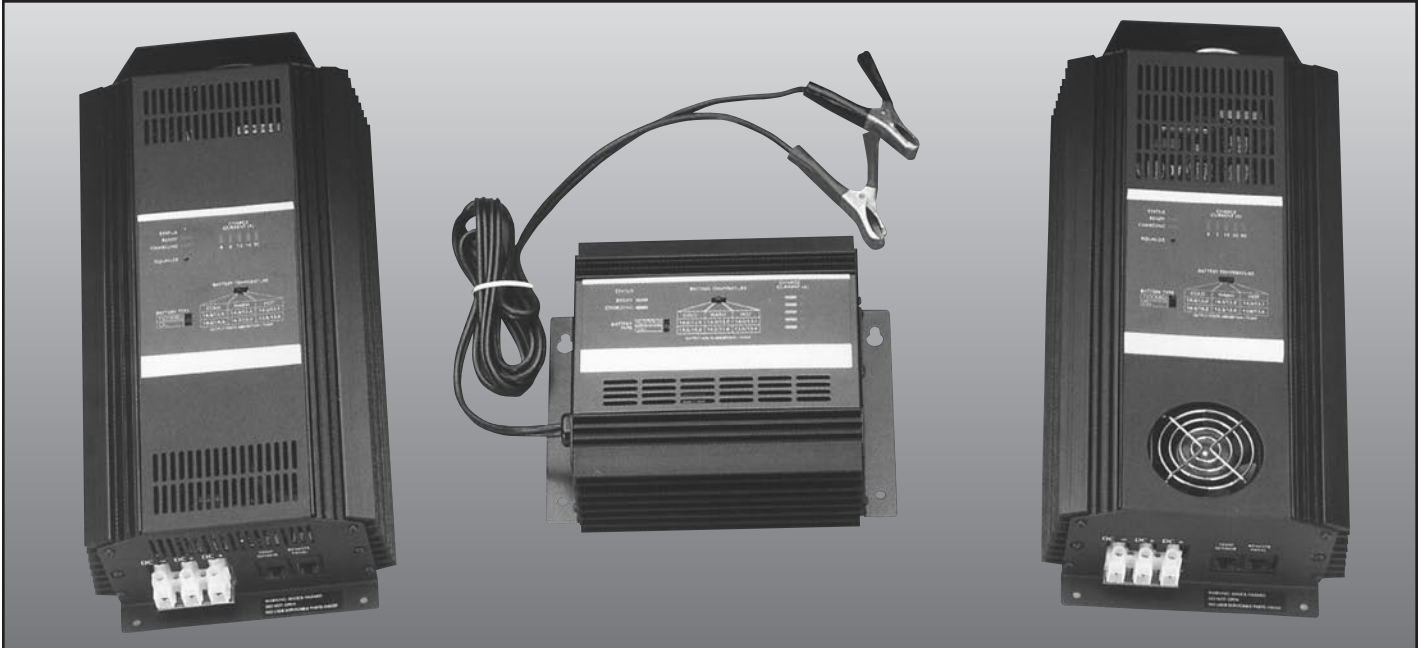

### MULTI-STAGE AUTOMATIC BATTERY CHARGERS

Ideal for deep cycle marine, RV, and industrial batteries

Microprocessor controlled, multi-step, fully automatic battery charging - charge faster than ferroresonant battery charges rated at twice each SMARTCHARGE model rating. Unique 21 day automatic battery top-up maintains battery charge.

#### SPECIAL FEATURES

**\* Battery Temperature Switch:**

Adjusts charging voltage to compensate for battery temperature, providing an accurate charge in any climate

**\* Battery READY and Battery Charging LED indicators:**

No more guessing if the battery is fully charged

**\* Battery Type Selector Switch:**

Adjusts charger output for the different charging requirements of sealed (gel) and conventional flooded (wet) batteries

**\* Bar graph Amp Meter:**

Displays battery charging current

**\* Equalization Mode:**

Manually triggered charge mode reconditions battery to maximum capacity on SMARTCHARGE 20 & 40

**\* Over-temperature, overload shutdown**

**\* Non-sparking feature for safe battery connection**

**\* Reverse polarity and short-circuit protection**

### SPECIFICATIONS

MODEL	SBC10	SBC20	SBC40
Output Current	10 amps continuous duty	20 amps continuous duty	40 amps continuous duty
Output Voltage Charge Float	All units: 13.8 - 14.8V DC (depending on settings) All units: 13.1 - 14.2V DC (depending on settings)		
Equalize	Not available	15.5V DC @ 4A max.	15.5V DC @ 4A max.
Input Voltage range	All units: 90 - 135V AC, 48-62Hz		
Weight	3.5 lbs. / 1.6 kg	5.5 lbs. / 2.5kg	7.0 lbs. / 3.2kg
Dimensions (L x W x H)	7.5" x 6.5" x 2.75"	15.5" x 6.5" x 2.75"	15.5" x 6.5" x 2.75"
Recommended for	12V lead-acid batteries	12V lead-acid batteries	12V lead-acid batteries
	25 Ah to 200 Ah	100 Ah to 400 Ah	400 Ah and up